

USER MANUAL

MAVERICK STORM 1SPOT



Edition Notes

The Maverick Storm 1 Spot User Manual includes a description, safety precautions, installation, programming, operation and maintenance instructions for the Maverick Storm 1 Spot as of the release date of this edition.

Trademarks

CHAUVET, the Chauvet logo and Maverick Storm 1 Spot are registered trademarks or trademarks of Chauvet & Sons, LLC (d/b/a Chauvet and Chauvet Lighting) in the United States and other countries. Other company and product names and logos referred to herein may be trademarks of their respective companies.

Copyright Notice

The works of authorship contained in this manual, including, but not limited to, all design, text and images are owned by Chauvet.

© **Copyright 2021 Chauvet & Sons, LLC. All rights reserved.**

Electronically published by Chauvet in the United States of America.

Manual Use

Chauvet authorizes its customers to download and print this manual for professional information purposes only. Chauvet expressly prohibits the usage, copy, storage, distribution, modification, or printing of this manual or its content for any other purpose without written consent from Chauvet.

Document Printing

For best results, print this document in color, on letter size paper (8.5 x 11 in), double-sided. If using A4 paper (210 x 297 mm), configure the printer to scale the content accordingly.

Intended Audience

Any person installing, operating, and/or maintaining this product should completely read through the guide that shipped with the product, as well as this manual, before installing, operating, or maintaining this product.

Disclaimer

Chauvet believes that the information contained in this manual is accurate in all respects. However, Chauvet assumes no responsibility and specifically disclaims any and all liability to any party for any loss, damage or disruption caused by any errors or omissions in this document, whether such errors or omissions result from negligence, accident or any other cause. Chauvet reserves the right to revise the content of this document without any obligation to notify any person or company of such revision, however, Chauvet has no obligation to make, and does not commit to make, any such revisions. Download the latest version from www.chauvetprofessional.com.

Document Revision

This Maverick Storm 1 Spot User Manual is the 3rd edition of this document. Go to www.chauvetprofessional.com for the latest version.

TABLE OF CONTENTS

1. Before You Begin	1
What Is Included	1
Claims	1
Text Conventions	1
Symbols	1
FCC Compliance	1
RF Exposure Warning for North America, and Australia.....	1
Safety Notes.....	2
Personal Safety	2
Mounting and Rigging	2
Power and Wiring.....	2
Operation	2
Expected LED Lifespan.....	2
2. Introduction.....	3
Description	3
Features	3
Product Overview.....	3
Product Dimensions	4
3. Setup.....	5
AC Power	5
AC Plug	5
Fuse Replacement.....	5
Power-linking.....	5
Remote Device Management (RDM).....	5
Mounting	6
Orientation.....	6
Rigging	6
Procedure.....	6
Signal Connections	7
Control Personalities	7
DMX Linking.....	7
Art-Net™ Connection	7
sACN Connection.....	7
Connection Diagram	7
4. Operation.....	8
Touchscreen Control Panel.....	8
Control Panel Description	8
Battery Powered Display	8
Home Screen	8
Control Panel Lock.....	8
Passcode	8
Followspot Mode	8
Menu Map	9
Configuration (DMX, Art-Net™, sACN)	13
Control Mode.....	13
Control Personalities	13
Starting Address.....	13
Network Setup.....	13
IP Mode.....	13
Universe.....	13
Manual IP Address.....	13
Subnet Mask	13
Control Channel Assignments and Values.....	14
DMX 33CH	14
DMX 26CH.....	17
Configuration (Settings)	20
Pan Reverse	20
Tilt Reverse	20
Screen Reverse	20
Pan Angle.....	20
Tilt Angle	20

Table of Contents

Blackout on Movement.....	20
Swap Pan and Tilt.....	20
WDMX Reset.....	20
Display Backlight Timer.....	20
Loss of Data.....	21
Fan Mode.....	21
Theatrical Dimming.....	21
Dimmer Curve.....	21
Pulse Width Modulation.....	21
Smart Zoom.....	21
Beam Correction.....	21
Preset Selection.....	21
Preset Synchronization.....	21
Reset Function.....	22
Factory Reset.....	22
Test Mode.....	22
Auto Test.....	22
Manual Test.....	22
System Information.....	22
Offset Mode (Zero Adjust).....	22
Web Server.....	23
Gobo Wheels.....	24
Gobo Dimensions for Gobo Wheel 1.....	24
Gobo Replacement.....	25
Color Wheel.....	26
5. Maintenance.....	27
Product Maintenance.....	27
6. Technical Specifications.....	28
7. Returns.....	29
8. Contact Us.....	30

1. Before You Begin

What Is Included

- Maverick Storm 1 Spot
- Seetronic Powerkon IP65 Power Cord
- 2 Omega Brackets with Mounting Hardware
- Quick Reference Guide

Claims

Carefully unpack the product immediately and check the container to make sure all the parts are in the package and are in good condition.



If the box or the contents (the product and included accessories) appear damaged from shipping, or show signs of mishandling, notify the carrier immediately, not Chauvet. Failure to report damage to the carrier immediately may invalidate your claim. In addition, keep the box and contents for inspection.

For other issues, such as missing components or parts, damage not related to shipping, or concealed damage, file a claim with Chauvet within 7 days of delivery.

Text Conventions

Convention	Meaning
1–512	A range of values
50/60	A set of values of which only one can be chosen
Settings	A menu option not to be modified
<ENTER>	A key to be pressed on the product’s control panel

Symbols

Symbol	Meaning
	Critical installation, configuration, or operation information. Not following these instructions may make the product not work, cause damage to the product, or cause harm to the operator.
	Important installation or configuration information. The product may not function correctly if this information is not used.
	Useful information.



Any reference to data or power connections in this manual assumes the use of Seetronic IP rated cables.



The term “DMX” used throughout this manual refers to the USITT DMX512-A digital data transmission protocol.

FCC Compliance

This device complies with Part 15 Part B of the FCC Rules. Operation is subject to the following two conditions:

1. This device may not cause harmful interference, and
2. This device must accept any interference received, including interference that may cause undesired operation.

Any changes or modifications not expressly approved by the party responsible for compliance could void the user’s authority to operate the equipment.

RF Exposure Warning for North America, and Australia

Warning! This equipment complies with FCC radiation exposure limits set forth for an uncontrolled environment. This equipment should be installed and operated with a minimum distance of 20cm between the radiator and your body. This transmitter must not be co-located or operating in conjunction with any other antenna or transmitter.

Before You Begin

Safety Notes

Read all the following safety notes before working with this product. These notes contain important information about the installation, usage, and maintenance of this product.



This product contains no user-serviceable parts. Any reference to servicing in this User Manual will only apply to properly trained, certified technicians. Do not open the housing or attempt any repairs.



All applicable local codes and regulations apply to proper installation of this product.

Personal Safety

- Avoid direct eye exposure to the light source while the product is on.
- Always disconnect the product from the power source before cleaning or replacing the fuse.
- Always connect the product to a grounded circuit to avoid the risk of electrocution.
- Do not touch the product's housing when operating because it may be very hot.

Mounting and Rigging

- This product is intended for professional use only.
- This product is not intended for permanent outdoor installation.
- DO NOT submerge this product (IP65). Regular outdoor operation is fine.
- CAUTION: When transferring product from extreme temperature environments, (e.g. cold truck to warm humid ballroom) condensation may form on the internal electronics of the product. To avoid causing a failure, allow product to fully acclimate to the surrounding environment before connecting it to power.
- Mount this product in a location with adequate ventilation, at least 20 in (50 cm) from adjacent surfaces.
- This product should be positioned so that prolonged staring into it at a distance closer than 11.5 ft (3.5 m) is not expected.
- Make sure there are no flammable materials close to this product while it is operating.
- When hanging this product, always secure to a fastening device using a safety cable.
- Never carry the product by the power cord.

Power and Wiring

- Make sure the power cord is not crimped or damaged.
- Always make sure you are connecting this product to the proper voltage in accordance with the specifications in this manual or on the product's specification label.
- To eliminate unnecessary wear and improve its lifespan, during periods of non-use completely disconnect the product from power via breaker or by unplugging it.
- Never connect this product to a dimmer pack or rheostat.
- Make sure to replace the fuse with another of the same type and rating.
- Never disconnect this product by pulling or tugging on the power cable.
- If the external flexible cable or cord of this product is damaged, it shall be replaced with a special cable or cord exclusively available from the manufacturer or its service agent.
- The light source contained in this product shall only be replaced by the manufacturer, its service agent, or a similarly qualified person.

Operation

- Do not operate this product if there is damage on the housing, lenses, or cables. Have the damaged parts replaced by an authorized technician at once.
- Do not cover the ventilation slots when operating to avoid internal overheating.
- The maximum ambient temperature is 113 °F (45 °C). Do not operate the product at higher temperatures.
- The minimum startup temperature is -4°F (-20°C). Do not start the product at lower temperatures.
- The minimum ambient temperature is -22°F (-30°C). Do not operate the product at lower temperatures.
- In the event of a serious operation problem, stop using this product immediately!



If your Chauvet product requires service, contact Chauvet Technical Support.

Expected LED Lifespan

Over time, use and heat will gradually reduce LED brightness. Clustered LEDs produce more heat than single LEDs, contributing to shorter lifespans if always used at full intensity. The average LED lifespan is 40,000 to 50,000 hours. To extend LED lifespan, maintain proper ventilation around the product and limit the overall intensity.

2. Introduction

Description

The Maverick Storm 1 Spot features CMY + CTO color mixing, a color wheel, animation wheel, and a fast 6.5:1 zoom ratio. It also has an integrated and controllable sunshield for protecting the optical system when fixture is not in use. The Maverick Storm 1 Spot offers static, rotating, and animation effects from its 2 gobo wheels (1 rotating, 1 static), animation wheel, 2 independent and overlapping prisms and 2 frost options: super-light and medium. Controllable with DMX, sACN, Art-Net or W-DMX.

Features

- Full featured IP rated 480W LED yoke spot fixture including CMY+CTO color mixing, a color wheel, animation wheel, 6.5:1 zoom, a 5 facet prism, two frosts, a static and rotating gobo wheel, and a patent-pending sunshield optical protection system
- 16-bit dimming of master dimmer for smooth control of fades
- Variable CMY + CTO color mixing system to create a wide pallet of colors
- Independently layerable five facet linear and five facet round prisms for increased prism options
- One rotating and one static gobo wheel for dynamic texture possibilities
- Independent light and medium frosts for beam control
- Animation wheel for enhanced visual effects
- Iris for total beam control
- RDM control over DMX for fixture reporting
- 7.1° to 51° zoom range for variable beam sizes
- Three menu presets and preset cross load for decreased shop setup time
- True 1 compatible power input
- Battery backup display with auto-rotate depending on fixture orientation
- Integrated and controllable sunshield for protecting optical system when fixture is not in use

Product Overview

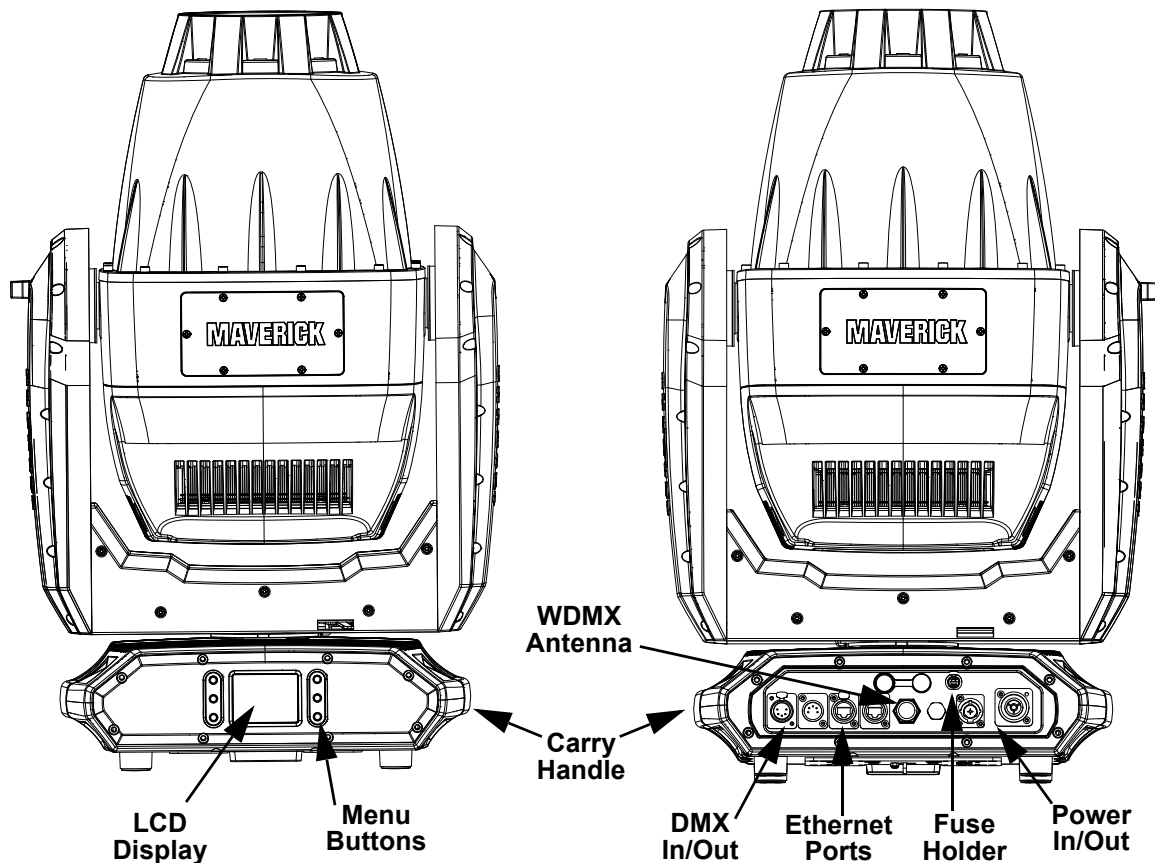

Product Dimensions

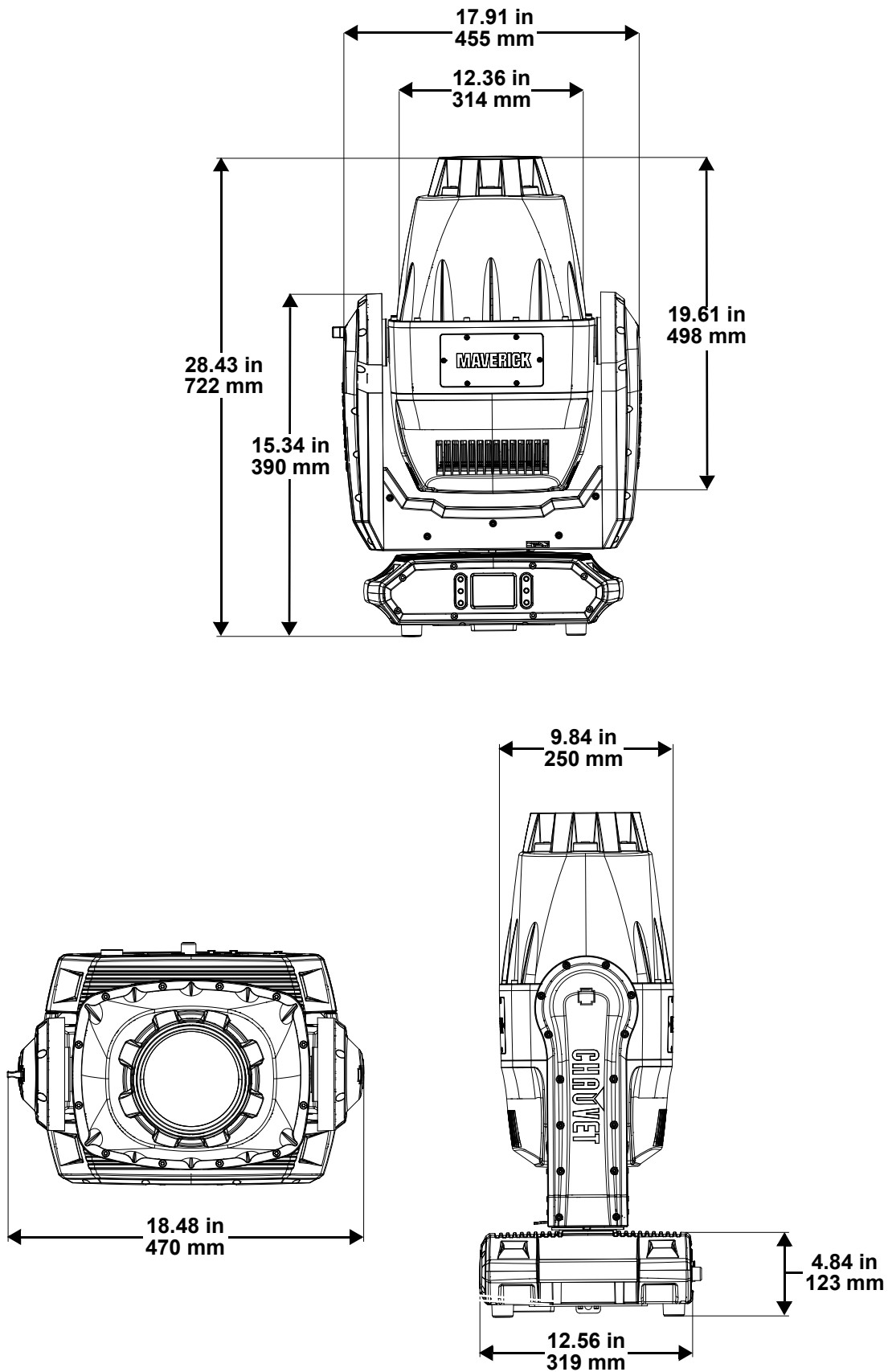

3. Setup

AC Power

The Maverick Storm 1 Spot has an auto-ranging power supply and it can work with an input voltage range of 100 to 240 VAC, 50/60 Hz.

To determine the product's power requirements (circuit breaker, power outlet, and wiring), use the current value listed on the label affixed to the product's back panel, or refer to the product's specifications chart. The listed current rating indicates the product's average current draw under normal conditions.



- **Always connect the product to a protected circuit (a circuit breaker or fuse). Make sure the product has an appropriate electrical ground to avoid the risk of electrocution or fire.**
- **To eliminate unnecessary wear and improve its lifespan, during periods of non-use completely disconnect the product from power via breaker or by unplugging it.**



Never connect the product to a rheostat (variable resistor) or dimmer circuit, even if the rheostat or dimmer channel serves only as a 0 to 100% switch.

AC Plug

The Maverick Storm 1 Spot comes with a power input cord terminated with a Seetronic Powerkon A connector on one end and an Edison plug on the other end (U.S. market). If the power input cord that came with your product has no plug, or if you need to change the plug, use the table below to wire the new plug.

Connection	Wire (U.S.)	Wire (Europe)	Screw Color
AC Live	Black	Brown	Yellow or Brass
AC Neutral	White	Blue	Silver
AC Ground	Green/Yellow	Green/Yellow	Green

Fuse Replacement

1. Disconnect this product from the power outlet.
2. Using a flat-head screwdriver, unscrew the fuse holder cap from the housing.
3. Remove the blown fuse and replace with another fuse of the same type and rating (F 20 A, 250 V).
4. Screw the fuse holder cap back in place and reconnect power.

Power-linking

Remote Device Management (RDM)

Remote Device Management, or RDM, is a standard for allowing DMX-enabled devices to communicate bi-directionally along existing DMX cabling. Check the DMX controller's User Manual or with the manufacturer as not all DMX controllers have this capability. The Maverick Storm 1 Spot supports RDM protocol that allows feedback to make changes to menu map options.

Setup

Mounting

Before mounting the product, read and follow the safety recommendations indicated in the [Safety Notes](#). For our CHAUVET Professional line of mounting clamps, go to <http://trusst.com/products/>.

Orientation

Always mount this product in a safe position, making sure there is adequate room for ventilation, configuration, and maintenance.

Rigging

Chauvet recommends using the following general guidelines when mounting this product.

- Before deciding on a location for the product, make sure there is easy access to the product for maintenance and programming purposes.
- Make sure that the structure onto which you are mounting the product can support the product's weight. See the [Technical Specifications](#) for weight information.
- When mounting the product overhead, always use a safety cable. Mount the product securely to a rigging point, whether an elevated platform or a truss.
- When rigging the product onto a truss, use a mounting clamp of appropriate weight capacity.

Procedure

The Maverick Storm 1 Spot comes with a bracket to which you can attach a mounting clamp directly. Mounting clamps are sold separately. Make sure the clamps are capable of supporting the weight of this product. Use at least two mounting points per product. For the CHAUVET Professional line of mounting clamps, go to <http://www.trusst.com/products>.

Mounting Diagram

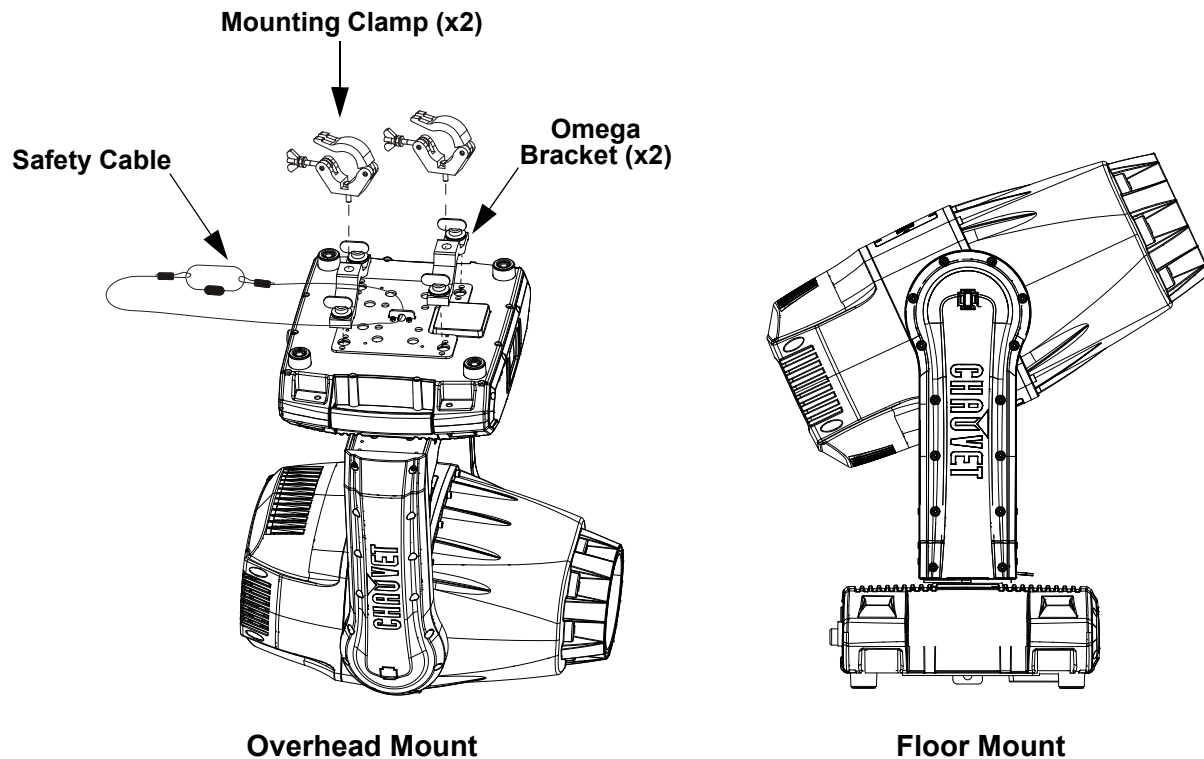

Signal Connections

The Maverick Storm 1 Spot can receive a DMX, Art-Net™, or sACN, signal. The Maverick Storm 1 Spot has two Amphenol XLRnet through ports, and 5-pin DMX in and out ports. If using other compatible products with this product, you can control each individually with a single controller.

Control Personalities

The Maverick Storm 1 Spot uses a 5-pin DMX data connection, WDMX, Art-Net™, or sACN for its two control personalities: **DMX 26CH** and **DMX 33CH**.

- Refer to the [Operation](#) chapter to learn how to configure the Maverick Storm 1 Spot to work in these personalities.
- The [Control Channel Assignments and Values](#) section provides detailed information regarding the control personalities.



If you are not familiar with or need more information about DMX standards or the DMX cables needed to link this product to a DMX controller, download the DMX Primer from the Chauvet website: www.chauvetprofessional.com.

DMX Linking

You can link the Maverick Storm 1 Spot to a DMX controller using a 5-pin DMX connection or a WDMX connection. For more information about DMX, read the DMX primer at: https://www.chauvetprofessional.com/wp-content/uploads/2016/06/DMX_Primer.pdf.

Art-Net™ Connection

Art-Net™ is an Ethernet protocol that uses TCP/IP that transfers a large amount of DMX512 data using an Amphenol XLRnet RJ45 connection over a large network. An Art-Net™ protocol document is available from www.chauvetprofessional.com.

Art-Net™ designed by and copyright Artistic Licence Holdings Ltd.

sACN Connection

Also known as ANSI E1.31, streaming ACN is an Ethernet protocol that uses the layering and formatting of Architecture for Control Networks to transport DMX512 data over IP or any other ACN-compatible network.

Connection Diagram

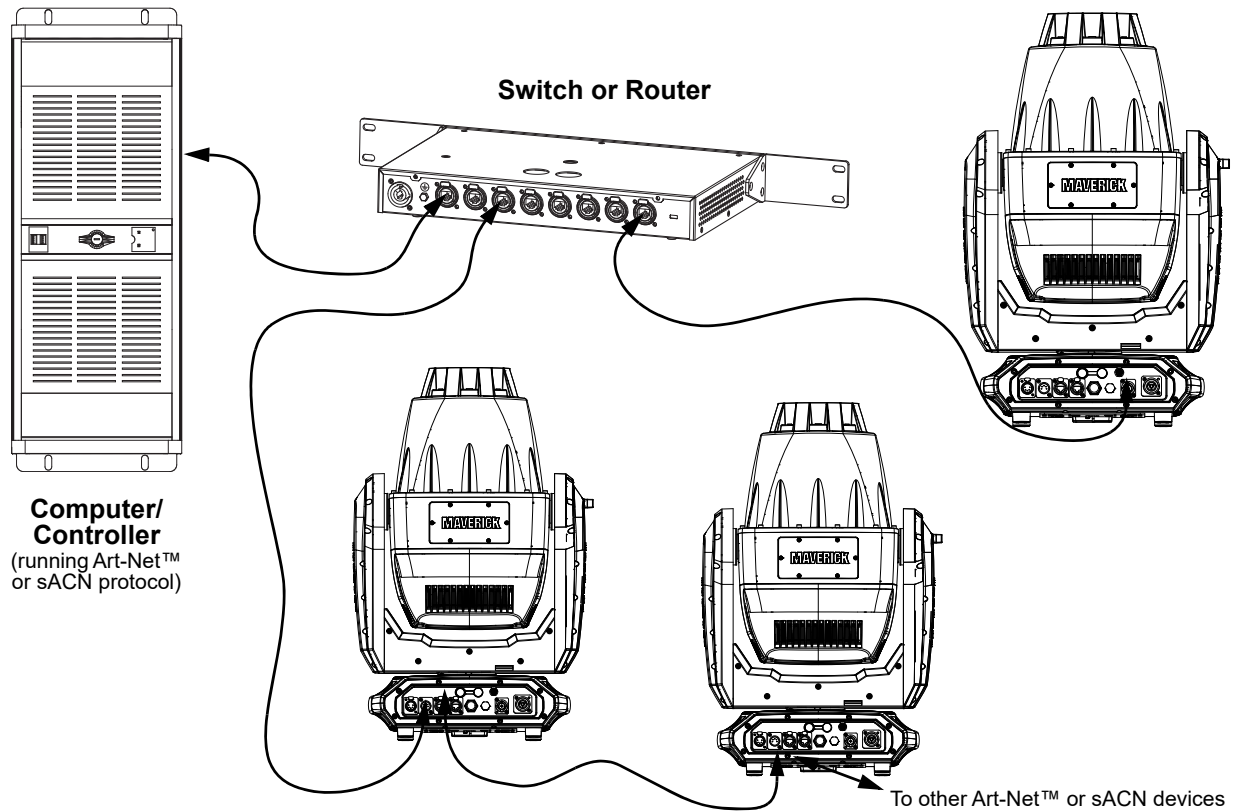







The three LED indicators in between the Ethernet through ports indicate a connection to a network and activity on that network. They do not indicate whether or not the Maverick Storm 1 Spot is receiving a signal from a controller.

4. Operation

Touchscreen Control Panel

The Maverick Storm 1 Spot has a touchscreen display as well as 6 control buttons. Navigate the menu structure by pressing the buttons, touching the images of the buttons on the sides of the display, or touching the desired menu option on the display directly. The touchscreen can be locked and calibrated through the Setup options in the menu.

Control Panel Description

Button	Function
	Navigates upwards through the menu list or increases the numeric value when in a function
	Exits from the current menu or function
	Navigates downwards through the menu list or decreases the numeric value when in a function
	Navigates leftwards through the menu list
	Enables the currently displayed menu or sets the currently selected value into the selected function
	Navigates rightwards through the menu list

Battery Powered Display

The Maverick Storm 1 Spot has a battery powered display which enables access to the menu when the product is powered off. Press and hold **<MENU>** until the display activates (approximately 15 seconds).

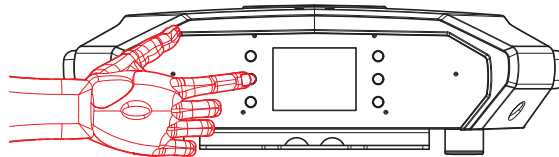

Home Screen

The Maverick Storm 1 Spot has a home screen that shows the current control protocols, personalities, starting addresses, IP addresses, and universes. To see the home screen, press **<MENU>** repeatedly until it shows on the display. From the home screen, touch any of the displayed control settings to immediately jump to that part of the menu, such as the personality, starting address, or universe, or press **<ENTER>** to reach the main menu.

Control Panel Lock

The setting locks or unlocks the control panel.

1. Go to the **Settings** main level.
2. Select the **Lock Screen** option.
3. Select **NO** (control panel stays unlocked) or **YES** (locks control panel).



When the control panel lock is activated, the product will prompt for the passcode in order to access the menu. Enter the passcode as described below.

Passcode

After being prompted to enter the passcode, press **<UP>**, **<DOWN>**, **<UP>**, **<DOWN>**, **<ENTER>**.

Followspot Mode

The followspot mode disables the pan and tilt motors, allowing the output of the product to be aimed by hand. To enable the followspot mode of the Maverick Storm 1 Spot, hold **<UP>** and **<LEFT>** while the product is powering on. When the product is turned off and back on, the pan and tilt will return to normal function.

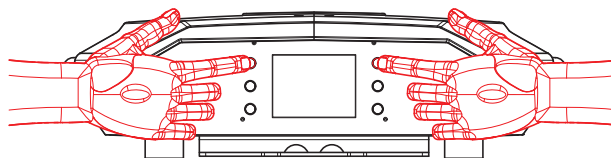

Menu Map

Main Level	Programming Levels		Description
Address	001–512		Sets the starting address
Network Setup	IP Mode	Manual	Manually set IP address
		DHCP	Network sets IP address
		Static	Product sets IP address
	Universe	000–255 (Art-Net™) 001–256 (sACN)	Sets the universe
	Ip	-----	Sets the IP address in Manual mode
SubMask	-----	Sets the Subnet Mask in Manual mode	
Personality	DMX 26CH	NO	Selects the 26-channel mode
		YES	
	DMX 33CH	NO	Selects the 33-channel mode
		YES	
Settings	Control Mode	DMX	Sets the control protocol
		WDMX	
		ArtNet	
		sACN	
	Pan Reverse	NO	Normal pan
		YES	Reversed pan
	Tilt Reverse	NO	Normal tilt
		YES	Reversed tilt
	Screen Reverse	NO	Normal display
		YES	Inverted display
		AUTO	Automatic display orientation
	Pan Angle	540	540° pan range
		360	360° pan range
		180	180° pan range
	Tilt Angle	270	270° tilt range
		180	180° tilt range
		90	90° tilt range
	BL. O. P/T Move	NO	Do not black out while panning/tilting
		YES	Blackout while panning/tilting
	BL. O. Color Move	NO	Do not black out while color wheel moving
		YES	Blackout while color wheel moving
	BL. O. Gobo Move	NO	Do not black out while gobo wheels moving
		YES	Blackout while gobo wheels moving
	Lock Screen	NO	Lock the buttons and touch screen. Passcode: 0920
		YES	
	Swap XY	NO	Do not swap pan and tilt
		YES	Pan controls tilt, tilt controls pan

Main Level	Programming Levels		Description
Settings (cont.)	WDMX Reset	NO	Do not reset WDMX
		YES	Reset WDMX
	Backlight Timer	30S	Display turns off after 30 seconds
		1M	Display turns off after 1 minute
		5M	Display turns off after 5 minutes
		ON	Display stays on
	Loss of Data	Hold	Holds last signal received
		Close	Blacks out fixture
	Fans	Auto	Fan speed according to product temperature
		Full	Fan speed set on high
		ECO	Quiet mode
	Theatrical Dimming	ON	Enable/Disable theatrical dimming
		OFF	
	Dimmer Curve	Linear	Set the dimmer curve
		Square	
		I Squa	
		SCurve	
	PWM Option	600Hz	Sets the Pulse Width Modulation frequency
		1200Hz	
		2000Hz	
		4000Hz	
		15000Hz	
	Smart Zoom	OFF	Enable/Disable smart zoom feature
ON			
Beam Correction	OFF	Enable/Disable the beam correction	
	ON		
Preset Select	PRESET A	Recorded preset menu options	
	PRESET B		
	PRESET C		
Preset Sync	NO	Allows recorded preset menu options to be transferred to other Maverick Storm 1 Spot fixtures in the DMX daisy chain	
	YES		
Reset Function	Pan/Tilt	NO/YES	
	Iris/Prism		
	Color/CMY		
	Gobo/Gobo Rotate		
	Frost		
	All		
Factory Settings	NO	Reset to factory default settings	
	YES		

Main Level	Programming Levels		Description	
Test	Auto Test		Auto test all functions	
	Manual Test	Pan	000-255	Manually control and test all settings through the control panel
		Pan Fine		
		Tilt		
		Tilt Fine		
		P/T Speed		
		Dimmer		
		Dimmer Fine		
		Shutter		
		Virtual Shaking		
		Cyan		
		Magenta		
		Yellow		
		CTO		
		Color		
		Gobo		
		Gobo Rotate		
		Gobo Index		
		Gobo2		
		Animation		
		Animation Rotate		
		Focus		
		Focus Fine		
		Focus Auto		
		Zoom		
		Zoom Fine		
		Prism		
		Prism Rotate		
		Iris		
	Frost			
Frost2				
CMY Macro				
CMY Macro Speed				
Special Function				
Information	Fixture Information	Ver	V_	Shows firmware version
		Running Mode	---	Shows current running mode
		DMX Address	---	Shows current starting address
		Temperature	---	Shows current product temperature in °C
		Fixture Hours	-----	Shows number of hours product has been powered on
		Ip	-----	Shows current IP address
		SubMask	-----	Shows current Subnet Mask
		MAC	-----	Shows current MAC address

Main Level	Programming Levels			Description
Information (cont.)	Fan Information	Base Fan1 Speed	----	Shows speed of head fans in rpm
		Base Fan2 Speed	----	
		head Fan1 Speed	----	
		head Fan2 Speed	----	
	Error Information		-----	Shows any errors, or No Error!
	Channel Information	Frequency	Hz	Shows all current values from input signals, 000–255
		Pan		
		Pan Fine		
		Tilt		
		Tilt Fine		
		P/T Speed		
		Dimmer		
		Dimmer Fine		
		Shutter		
		Virtual Shaking		
		Cyan		
		Magenta		
		Yellow		
		CTO		
		Color		
		Gobo		
		Gobo Rotate		
		Gobo Index	---	
		Gobo2		
		Animation		
		Animation Rotate		
		Focus		
Focus Fine				
Focus Auto				
Zoom				
Zoom Fine				
Prism				
Prism Rotate				
Iris				
Frost				
Frost2				
CMY Macro				
CMY Macro Speed				
Special Function				

Configuration (DMX, Art-Net™, sACN)

Use control configurations to operate the product with a DMX, Art-Net™, or sACN controller.

Control Mode

The Maverick Storm 1 Spot works with wired DMX, WDMX, Art-Net™, and sACN control signals. To select which protocol to use:

1. Go to the **Settings** main level.
2. Select the **Control Mode** option.
3. Select the desired protocol, from **DMX**, **WDMX**, **ArtNet**, or **sACN**.



- See the [WDMX Reset](#) section for further setup of WDMX.
- See the [Network Setup](#) section for further setup of Ethernet protocols (Art-Net™ or sACN).

Control Personalities

To set the control personality:

1. Go to the **Personality** main level.
2. Select the desired personality, from **DMX 26CH** or **DMX 33CH**.



- See the [Starting Address](#) section for the highest starting address you can select for each personality.
- Make sure that the starting addresses on the various products do not overlap due to the new personality setting.

Starting Address

Each product will respond to a unique starting address from the controller. All products with the same starting address will respond in unison. To set the starting address:

1. Go to the **Address** main level.
2. Select the starting address (**000–512**).
 - The highest recommended starting address for **DMX 26CH** is **512**.
 - The highest recommended starting address for **DMX 33CH** is **498**.

Network Setup

The Network Setup settings control the IP address, subnet mask, and universe of the product.

IP Mode

To choose how the IP address is set:

1. Go to the **Network Setup** main level.
2. Select the **IP Mode** option.
3. Select the desired IP mode, from **Manual** (to set a custom IP address), **DHCP** (the IP address is assigned by the connected network), or **Static** (the product uses a default, preset IP address).

Universe

To assign an Art-Net™ or sACN universe to the Maverick Storm 1 Spot:

1. Go to the **Network Setup** main level.
2. Select the **Universe** option.
3. Set the universe, from **000–255** (for Art-Net™) or from **001–256** (for sACN).

Manual IP Address

To set the IP address when the **IP Mode** is set to **Manual**:

1. Go to the **Network Setup** main level.
2. Select the **Ip** option.
3. Set the 4 values of the IP address from **000–255**.

Subnet Mask

To set the subnet mask:

1. Go to the **Network Setup** main level.
2. Select the **SubMask** option.
3. Set the 4 values of the subnet mask from **000–255**.

Operation

Control Channel Assignments and Values

DMX 33CH

Channel	Function	Value	Percent/Setting
1	Pan	000 ⇄ 255	0–100%
2	Fine Pan	000 ⇄ 255	Fine control (16-bit)
3	Tilt	000 ⇄ 255	0–100%
4	Fine Tilt	000 ⇄ 255	Fine control (16-bit)
5	Pan/Tilt Speed	000 ⇄ 255	Fast to slow
6	Dimmer	000 ⇄ 255	0–100%
7	Fine Dimmer	000 ⇄ 255	Fine control (16-bit)
8	Strobe	000 ⇄ 003	Closed
		004 ⇄ 007	Open
		008 ⇄ 076	Strobe, slow to fast
		077 ⇄ 145	Pulse strobe, slow to fast
		146 ⇄ 215	Random strobe, slow to fast
		216 ⇄ 255	Open
9	Virtual Strobe	000 ⇄ 001	No function
		002 ⇄ 128	Shaking strobe, slow to fast
		129 ⇄ 255	Fading shake, slow to fast
10	Cyan	000 ⇄ 255	0–100%
11	Magenta	000 ⇄ 255	0–100%
12	Yellow	000 ⇄ 255	0–100%
13	CTO	000 ⇄ 255	0–100%
14	Color Wheel	000 ⇄ 006	Open
		007 ⇄ 013	Red
		014 ⇄ 020	Orange
		021 ⇄ 027	Green
		028 ⇄ 034	Blue
		035 ⇄ 041	Magenta
		042 ⇄ 048	UV
		049 ⇄ 059	CTO
		060 ⇄ 187	Split color
		188 ⇄ 219	Color scroll, fast to slow
		220 ⇄ 223	Stop
		224 ⇄ 255	Reverse color scroll, slow to fast
15	Gobo Wheel 1	000 ⇄ 007	Open
		008 ⇄ 015	Gobo 1 (Sail Boats)
		016 ⇄ 023	Gobo 2 (Radial Dot)
		024 ⇄ 031	Gobo 3 (Mower Blade)
		032 ⇄ 039	Gobo 4 (Bolts)
		040 ⇄ 047	Gobo 5 (Shower Glass)
		048 ⇄ 055	Gobo 6 (Ballistic Clouds)
		056 ⇄ 063	Gobo 7 (Four Eyes)
		064 ⇄ 071	Gobo 7 shaking
		072 ⇄ 079	Gobo 6 shaking
		080 ⇄ 087	Gobo 5 shaking
		088 ⇄ 095	Gobo 4 shaking
		096 ⇄ 103	Gobo 3 shaking
		104 ⇄ 111	Gobo 2 shaking
		112 ⇄ 119	Gobo 1 shaking
		120 ⇄ 127	Open
		128 ⇄ 191	Gobo scroll, slow to fast
		192 ⇄ 255	Reverse gobo scroll, slow to fast

Channel	Function	Value	Percent/Setting
16	Gobo 1 Rotate	000 ⇔ 063	Rotating gobo index
		064 ⇔ 145	Gobo rotation, fast to slow
		146 ⇔ 149	Stop
		150 ⇔ 231	Reverse gobo rotation, slow to fast
		232 ⇔ 255	Bounce effect, short to long
17	Gobo Wheel 1 Indexing	000 ⇔ 255	Fine control (16-bit)
18	Gobo Wheel 2	000 ⇔ 005	Open
		006 ⇔ 011	Gobo 1 (Beam)
		012 ⇔ 017	Gobo 2 (Bars)
		018 ⇔ 023	Gobo 3 (Circles)
		024 ⇔ 029	Gobo 4 (Breakup)
		030 ⇔ 035	Gobo 5 (Dots)
		036 ⇔ 041	Gobo 6 (Circuits)
		042 ⇔ 047	Gobo 7 (Triangles)
		048 ⇔ 053	Gobo 8 (Forest)
		054 ⇔ 063	Gobo 9 (Rainbows)
		064 ⇔ 069	Gobo 9 shaking
		070 ⇔ 075	Gobo 8 shaking
		076 ⇔ 081	Gobo 7 shaking
		082 ⇔ 087	Gobo 6 shaking
		088 ⇔ 093	Gobo 5 shaking
		094 ⇔ 099	Gobo 4 shaking
		100 ⇔ 105	Gobo 3 shaking
106 ⇔ 111	Gobo 2 shaking		
112 ⇔ 117	Gobo 1 shaking		
118 ⇔ 127	Open		
128 ⇔ 191	Gobo scroll, slow to fast		
192 ⇔ 255	Reverse gobo scroll, slow to fast		
19	Animation Wheel	000 ⇔ 255	Animation effect, 0–100%
20	Animation Wheel Rotate	000 ⇔ 124	Animation wheel rotation, fast to slow
		125 ⇔ 130	Stop
		131 ⇔ 255	Reverse animation wheel, slow to fast
21	Focus	000 ⇔ 255	0–100%
22	Fine Focus	000 ⇔ 255	Fine control (16-bit)
23	Auto Focus	000 ⇔ 010	No function
		011 ⇔ 030	0–5 m
		031 ⇔ 050	6 m
		051 ⇔ 070	7 m
		071 ⇔ 090	8 m
		091 ⇔ 110	9 m
		111 ⇔ 130	10 m
		131 ⇔ 150	12.5 m
		151 ⇔ 170	15 m
		171 ⇔ 190	17.5 m
		191 ⇔ 210	20–60 m
211 ⇔ 255	Auto-detect distance		
24	Zoom	000 ⇔ 255	0–100%
25	Fine Zoom	000 ⇔ 255	Fine control (16-bit)
26	Prism	000 ⇔ 004	No function
		005 ⇔ 255	Prism effect
27	Prism Rotate	000 ⇔ 127	Rotating prism index
		128 ⇔ 189	Prism rotation, fast to slow
		190 ⇔ 193	Stop
		194 ⇔ 255	Reverse prism rotation, slow to fast

Operation

Channel	Function	Value	Percent/Setting
28	Iris	000 ⇄ 063	Big to small
		064 ⇄ 127	Auto change, slow to fast
		128 ⇄ 191	Slow expand, fast shrink (slow to fast)
		192 ⇄ 255	Slow shrink, fast expand (slow to fast)
29	Frost 1	000 ⇄ 255	0–100%
30	Frost 2	000 ⇄ 255	0–100%
31	CMY Macro	000 ⇄ 009	No function
		010 ⇄ 255	CMY macro
32	CMY Macro Speed	000 ⇄ 255	CMY macro speed, fast to slow
33	Control	000 ⇄ 007	No function
		008 ⇄ 015	XY blackout
		016 ⇄ 023	C blackout
		024 ⇄ 031	G blackout
		032 ⇄ 039	XY/C blackout
		040 ⇄ 047	XY/G blackout
		048 ⇄ 055	XY/C/G blackout
		056 ⇄ 095	No function
		096 ⇄ 103	X reset
		104 ⇄ 111	Y reset
		112 ⇄ 119	Color reset
		120 ⇄ 127	Gobo wheels and rotation reset
		128 ⇄ 135	No function
		136 ⇄ 143	Prism reset
		144 ⇄ 151	No function
		152 ⇄ 159	All reset
		160 ⇄ 167	Iris reset
		168 ⇄ 175	Frost reset
		176 ⇄ 183	No function
		184 ⇄ 191	CMY reset
		192 ⇄ 199	Fan ECO mode
		200 ⇄ 207	Fan full speed
		208 ⇄ 215	Fan auto
		216 ⇄ 220	No function
		221 ⇄ 225	Iris fast mode
		226 ⇄ 230	Iris smooth mode
		231 ⇄ 235	XY swap on
		236 ⇄ 240	XY swap off
		241 ⇄ 245	No function
		246 ⇄ 250	XY smooth mode
251 ⇄ 255	XY fast mode		

DMX 26CH

Channel	Function	Value	Percent/Setting
1	Pan	000 ⇔ 255	0–100%
2	Fine Pan	000 ⇔ 255	Fine control (16-bit)
3	Tilt	000 ⇔ 255	0–100%
4	Fine Tilt	000 ⇔ 255	Fine control (16-bit)
5	Pan/Tilt Speed	000 ⇔ 255	Fast to slow
6	Dimmer	000 ⇔ 255	0–100%
7	Strobe	000 ⇔ 003	Closed
		004 ⇔ 007	Open
		008 ⇔ 076	Strobe, slow to fast
		077 ⇔ 145	Pulse strobe, slow to fast
		146 ⇔ 215	Random strobe, slow to fast
		216 ⇔ 255	Open
8	Virtual Strobe	000 ⇔ 001	No function
		002 ⇔ 128	Shaking strobe, slow to fast
		129 ⇔ 255	Fade in/out, slow to fast
9	Cyan	000 ⇔ 255	0–100%
10	Magenta	000 ⇔ 255	0–100%
11	Yellow	000 ⇔ 255	0–100%
12	CTO	000 ⇔ 255	0–100%
13	Color Wheel	000 ⇔ 006	Open
		007 ⇔ 013	Red
		014 ⇔ 020	Orange
		021 ⇔ 027	Green
		028 ⇔ 034	Blue
		035 ⇔ 041	Magenta
		042 ⇔ 048	UV
		049 ⇔ 059	CTO
		060 ⇔ 187	Split color
		188 ⇔ 219	Color scroll, fast to slow
		220 ⇔ 223	Stop
		224 ⇔ 255	Reverse color scroll, slow to fast
14	Gobo Wheel 1	000 ⇔ 007	Open
		008 ⇔ 015	Gobo 1 (Sail Boats)
		016 ⇔ 023	Gobo 2 (Radial Dot)
		024 ⇔ 031	Gobo 3 (Mower Blade)
		032 ⇔ 039	Gobo 4 (Bolts)
		040 ⇔ 047	Gobo 5 (Shower Glass)
		048 ⇔ 055	Gobo 6 (Ballistic Clouds)
		056 ⇔ 063	Gobo 7 (Dots)
		064 ⇔ 071	Gobo 7 shaking
		072 ⇔ 079	Gobo 6 shaking
		080 ⇔ 087	Gobo 5 shaking
		088 ⇔ 095	Gobo 4 shaking
		096 ⇔ 103	Gobo 3 shaking
		104 ⇔ 111	Gobo 2 shaking
		112 ⇔ 119	Gobo 1 shaking
		120 ⇔ 127	Open
		128 ⇔ 191	Gobo scroll, slow to fast
		192 ⇔ 255	Reverse gobo scroll, slow to fast

Operation

Channel	Function	Value	Percent/Setting
15	Gobo 1 Rotate	000 ⇄ 063	Rotating gobo index
		064 ⇄ 145	Gobo rotation, fast to slow
		146 ⇄ 149	Stop
		150 ⇄ 231	Reverse gobo rotation, slow to fast
		232 ⇄ 255	Bounce effect
16	Gobo Wheel 2	000 ⇄ 005	Open
		006 ⇄ 011	Gobo 1 (Beam)
		012 ⇄ 017	Gobo 2 (Bars)
		018 ⇄ 023	Gobo 3 (Circles)
		024 ⇄ 029	Gobo 4 (Breakup)
		030 ⇄ 035	Gobo 5 (Four Eyes)
		036 ⇄ 041	Gobo 6 (Circuits)
		042 ⇄ 047	Gobo 7 (Triangles)
		048 ⇄ 053	Gobo 8 (Forest)
		054 ⇄ 063	Gobo 9 (Rainbows)
		064 ⇄ 069	Gobo 9 shaking
		070 ⇄ 075	Gobo 8 shaking
		076 ⇄ 081	Gobo 7 shaking
		082 ⇄ 087	Gobo 6 shaking
		088 ⇄ 093	Gobo 5 shaking
		094 ⇄ 099	Gobo 4 shaking
		100 ⇄ 105	Gobo 3 shaking
106 ⇄ 111	Gobo 2 shaking		
112 ⇄ 117	Gobo 1 shaking		
118 ⇄ 127	Open		
128 ⇄ 191	Gobo scroll, slow to fast		
192 ⇄ 255	Reverse gobo scroll, slow to fast		
17	Animation Wheel	000 ⇄ 255	Animation effect
18	Animation Wheel Rotate	000 ⇄ 255	Animation wheel rotation, fast to slow
		000 ⇄ 255	Stop
		000 ⇄ 255	Reverse animation wheel, slow to fast
19	Focus	000 ⇄ 255	0–100%
20	Zoom	000 ⇄ 255	0–100%
21	Prism	000 ⇄ 004	No function
		005 ⇄ 255	Prism effect
22	Prism Rotate	000 ⇄ 127	Rotating prism 1 index
		128 ⇄ 189	Prism 1 rotation, fast to slow
		190 ⇄ 193	Stop
		194 ⇄ 255	Reverse prism 1 rotation, slow to fast
23	Iris	000 ⇄ 063	Big to small
		064 ⇄ 127	Auto change, slow to fast
		128 ⇄ 191	Slow zoom out, fast zoom in (slow to fast)
		192 ⇄ 255	Slow zoom in, fast zoom out (slow to fast)
24	Frost 1	000 ⇄ 255	0–100%
25	Frost 2	000 ⇄ 255	0–100%

Channel	Function	Value	Percent/Setting
26	Control	000 ⇔ 007	No function
		008 ⇔ 015	XY blackout
		016 ⇔ 023	C blackout
		024 ⇔ 031	G blackout
		032 ⇔ 039	XY/C blackout
		040 ⇔ 047	XY/G blackout
		048 ⇔ 055	XY/C/G blackout
		056 ⇔ 095	No function
		096 ⇔ 103	X reset
		104 ⇔ 111	Y reset
		112 ⇔ 119	Color reset
		120 ⇔ 127	Gobo wheels and rotation reset
		128 ⇔ 135	No function
		136 ⇔ 143	Prisms reset
		144 ⇔ 151	Framing shutter reset
		152 ⇔ 159	All reset
		160 ⇔ 167	Iris reset
		168 ⇔ 175	Frost reset
		176 ⇔ 183	Zoom reset
		184 ⇔ 191	CMY reset
		192 ⇔ 199	Fan low speed
		200 ⇔ 207	Fan full speed
		208 ⇔ 215	Fan auto
		216 ⇔ 220	No function
		221 ⇔ 225	Iris fast mode
		226 ⇔ 230	Iris smooth mode
		231 ⇔ 235	XY swap on
		236 ⇔ 240	XY swap off
		241 ⇔ 245	No function
		246 ⇔ 250	XY smooth mode
		251 ⇔ 255	XY fast mode

Operation

Configuration (Settings)

Pan Reverse

To set the orientation of the pan:

1. Go to the **Settings** main level.
2. Select the **Pan Reverse** option.
3. Select from **NO** (normal pan motion), or **YES** (reversed pan motion).

Tilt Reverse

To set the orientation of the tilt:

1. Go to the **Settings** main level.
2. Select the **Tilt Reverse** option.
3. Select from **NO** (normal tilt motion), or **YES** (reversed tilt motion).

Screen Reverse

To set the orientation of the display:

1. Go to the **Settings** main level.
2. Select the **Screen Reverse** option.
3. Select from **NO** (right-side up), **YES** (upside-down), or **AUTO** (changes depending on the orientation of the product).

Pan Angle

To set the maximum angle of the pan:

1. Go to the **Settings** main level.
2. Select the **Pan Angle** option.
3. Select from **540** (540°), **360** (360°), or **180** (180°).

Tilt Angle

To set the maximum angle of the tilt:

1. Go to the **Settings** main level.
2. Select the **Tilt Angle** option.
3. Select from **270** (270°), **180** (180°), or **90** (90°).

Blackout on Movement

To set the Maverick Storm 1 Spot to black out on pan or tilt movement, color wheel movement, or gobo wheel movement:

1. Go to the **Settings** main level.
2. Select the **BL. O. P/T Move** (blackout on pan or tilt movement), **BL. O. Color Move** (blackout on color wheel movement), or **BL. O. Gobo Move** (blackout on gobo wheel movement) option.
3. Select from **NO** (no blackout on selected movement), or **YES** (blackout during the selected movement).

Swap Pan and Tilt

To swap the pan and tilt controls for each other:

1. Go to the **Settings** main level.
2. Select the **Swap XY** option.
3. Select from **NO** (do not swap), or **YES** (swap so pan controls tilt and tilt controls pan).

WDMX Reset

To reset the WDMX connection and allow the Maverick Storm 1 Spot to connect to a WDMX transmitter:

1. Go to the **Settings** main level.
2. Select the **WDMX Reset** option.
3. Select from **NO** (do not reset), or **YES** (reset the WDMX connection).



Follow instructions in the manual or guide for the WDMX controller being used to connect it to the receiver in the Maverick Storm 1 Spot.

Display Backlight Timer

To set the length of time before an inactive display will turn off:

1. Go to the **Settings** main level.
2. Select the **Backlight Timer** option.
3. Select the length of the backlight timer, from **30S** (30 seconds), **1M** (1 minute), **5M** (5 minutes), or **ON** (always on).

Loss of Data

To set how the product reacts to a loss in control signal data:

1. Go to the **Settings** main level.
2. Select the **Los of Data** option.
3. Select from **Hold** (holds the last values received before signal loss), or **Close** (blacks out the product).

Fan Mode

To set the fan speed mode:

1. Go to the **Settings** main level.
2. Select the **Fans** option.
3. Select the fan mode, from **Auto** (fan speed adjusts to product temperature), **Full** (fan speed at maximum), or **ECO** (quiet mode).

Theatrical Dimming

To configure the theatrical dimming feature:

1. Go to the **Settings** main level.
2. Select the **Theatrical Dimming** option.
3. Select from **ON** (enabled), or **OFF** (disabled).

Dimmer Curve

To set the dimmer curve:

1. Go to the **Settings** main level.
2. Select the **Dimmer Curve** option.
3. Select the dimmer curve, from **Linear**, **Square**, **I Squa**, or **SCurve**.

Pulse Width Modulation

To adjust the frequency of the pulse width modulation:

1. Go to the **Settings** main level.
2. Select the **PWM Option** option.
3. Select the frequency, from **600Hz**, **1200Hz**, **2000Hz**, **4000Hz**, **6000Hz**, or **15000Hz**.

Smart Zoom

To configure the smart zoom feature:

1. Go to the **Settings** main level.
2. Select the **Smart Zoom** option.
3. Select from **ON** (enabled), or **OFF** (disabled).

Beam Correction

To set the beam correction feature:

1. Go to the **Settings** main level.
2. Select the **Beam Correction** option.
3. Select from **ON** (enabled), or **OFF** (disabled).

Preset Selection

To select a preset configuration of menu options:

1. Go to the **Settings** main level.
2. Select the **Preset Select** option.
3. Select from **PRESET A** (default), **PRESET B**, or **PRESET C**.



- **Changes to settings automatically save to the currently selected Preset.**
- **If no Preset has been selected, changes to settings save to PRESET A.**
- **After selecting a Preset, the product will restart.**

Preset Synchronization

To transfer saved Presets from one Maverick Storm 1 Spot to another:

1. Connect the Maverick Storm 1 Spot products to receive the Presets by a DMX daisy chain.
2. Make the Maverick Storm 1 Spot with the Presets to transfer the first in the DMX daisy chain.
3. Power on all of the products.
4. Set all of the products to a [Control Mode](#) other than **WDMX**. (**DMX**, **ArtNet**, or **sACN**)
5. On the Maverick Storm 1 Spot with the Presets, go to the **Settings** main level.
6. Select the **Preset Sync** option.
7. Select **NO** (to cancel) or **YES** (to transfer the Presets to the connected products).



- **All menu configurations are transferred except for the IP address.**
- **ONLY connect Maverick Storm 1 Spot products for this function!**

Operation

Reset Function

To reset specific functions or the entire product:

1. Go to the **Settings** main level.
2. Select the **Reset Function** option.
3. Select the functions to reset, from:
 - **Pan/Tilt**
 - **Iris/Prism**
 - **Color/CMY/Blade**
 - **Gobo/Gobo Rotate**
 - **Frost/Animation**
 - or
 - **All**
4. Select **NO** (to cancel) or **YES** (to reset the selected functions).

Factory Reset

To reset the product to factory settings:

1. Go to the **Settings** main level.
2. Select the **Factory Reset** option.
3. Select **NO** (to cancel) or **YES** (to reset the product configuration).

Test Mode

Auto Test

To have the Maverick Storm 1 Spot automatically test all functions one after the other:

1. Go to the **Test** main level.
2. Select the **Auto Test** option.

Manual Test

To manually test an individual function of the Maverick Storm 1 Spot:

1. Go to the **Test** main level.
2. Select the **Manual Test** option.
3. Select a function to test, from **Pan, Pan Fine, Tilt, Tilt Fine, P/T Speed, Dimmer, Dimmer Fine, Shutter, Virtual Shaking, Cyan, Magenta, Yellow, CTO, Color, Gobo, Gobo Rotate, Gobo Index, Gobo2, Animation, Animation Rotate, Focus, Focus Fine, Focus Auto, Zoom, Zoom Fine, Prism, Prism Rotate, Iris, Frost, Frost2, CMY Macro, CMY Macro Speed, or Special Function.**
4. Increase or decrease the value of the selected function from **000–255** to test it.

System Information

The information section of the menu displays statistics and the current status of the product's various functions. To view these information sections:

1. Go to the **Information** main level.
2. Select which information to view, from **Fixture Information** (shows the firmware version, running mode, addresses, temperature, and running time), **Fan Information** (shows the speed of the fans in rotations per minute (rpm)), **Error Information** (shows any error or No Error!), or **Channel Information** (shows the current values of all signal input channels).
3. If necessary, scroll up and down to view all information available in the selected option.

Offset Mode (Zero Adjust)

The Offset mode provides fine adjustments for the home position of every moving part in the optical path as well as the pan and tilt movements. To adjust these options and prevent borders showing or reduction of the light output:

1. From the main level screen, press and hold **<MENU>** until the passcode screen appears.
2. Enter the passcode: **2323** and press **<ENTER>**.
3. Select the "zero" position to adjust, from **PAN, TILT, COLOR, GOBO, GOBO ROTATE, GOBO2, ANIMATION, FOCUS-GOBO, FOCUS-GOBO2, ZOOM, PRISM, PRISM ROT, IRIS, FROST, FROST2, CYAN, MAGENTA, YELLOW, CTO, DIMMER, MAC4, MAC5, or MAC6.**
4. Adjust the "zero" position for the selected function from **000–255**.

Web Server

The Maverick Storm 1 Spot Web Server can be accessed by any computer on the same network as the product. It allows network access to system information, settings such as control setup, manual testing of all functions, firmware updates, and the ability to change the Web Server password.

1. Connect the product to power, and set the [Control Mode](#) to **ArtNet** and the [IP Mode](#) to **Static**.
2. Connect the product to a Windows computer with a network cable.
3. On the computer, set the first value of the IP address of the new network to match the first value of the IP address of the product. The IP address of the product is displayed on the [Home Screen](#).
4. Enter the IP address of the product into the URL bar of a web browser on the computer.
5. Enter both the User Name and Password as **admin** to log in.

Information

The Information page on the Web Server displays the current settings and the system information of the Maverick Storm 1 Spot.

Setup

The Setup page on the Web Server provides options for control, similar to the **Setup** menu on the product. Click **Save Settings** to send the new configuration to the product.

Manual Test

The Manual Test page on the Web Server allows all output functions of the product to be controlled through the browser. To set all functions back to default, click **Reset**.

Firmware Update

The Upgrade page on the Web Server allows the product to be updated with the latest firmware. Go to <https://www.chauvetprofessional.com> to download firmware updates.

Security

The Security page on the Web Server gives the option to change the password to the connected product's web server. Enter the old password (**admin**, by default) and the new password twice, then click **Save Settings** to change the password.

Operation

Gobo Wheels

Gobo Wheel 1
Rotating Gobo Wheel

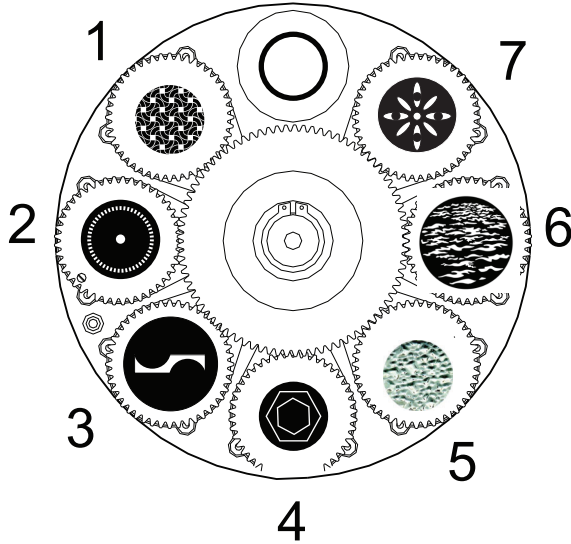

Gobo Wheel 2
Static Gobo Wheel

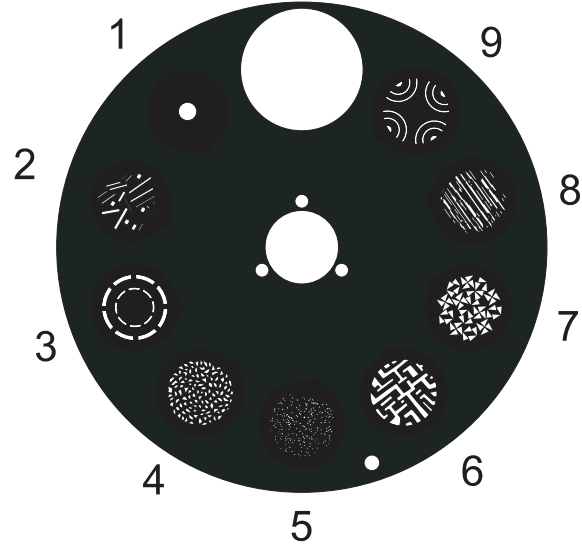

Gobo Wheel	Gobo #	Description	Gobo Wheel	Gobo #	Description
1	1	Sail Boats	2	1	Beam
	2	Radial Dot		2	Bars
	3	Mower Blade		3	Circles
	4	Bolts		4	Breakup
	5	Shower Glass		5	Dots
	6	Ballistic Clouds		6	Circuits
	7	Four Eyes		7	Triangles
				8	Forest
				9	Rainbows

Gobo Dimensions for Gobo Wheel 1

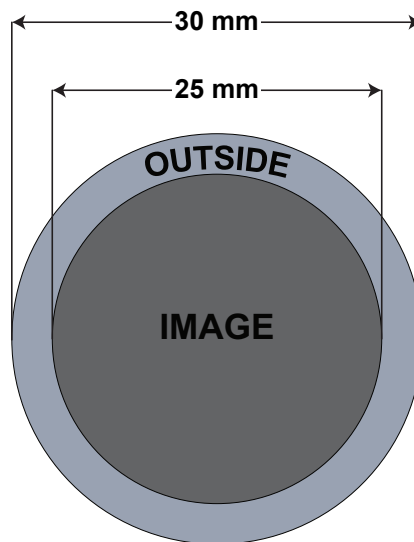

Gobo Replacement

The gobos in gobo wheel 1 are removable from their gobo holder. This operation is quite simple, although it requires the technician to carefully follow the recommended procedure.

- **Make sure to disconnect the product's power cord before replacing a gobo.**
- **Always replace a gobo with a gobo of the same dimensions.**
- **When inserting a glass gobo, always make sure that the shiny side of the gobo (glass base) faces the lamp. This provides a layer of protection against the high temperature from the lamp.**

Procedure

1. Turn the product off and disconnect it from the power outlet.
2. Open the gobo door by loosening the screws around the door.
3. Separate the gobo holder away from the gobo wheel by pushing it toward the front of the moving head. Be careful not to push the gobo out of the gobo holder.
4. Extract the gobo holder by pulling it outward.
5. On a flat surface, remove the expansion ring that holds the gobo in place and remove the gobo from the gobo holder.
6. Insert a new gobo and hold it in place with the expansion ring.
7. Slide the tip of the gobo holder under the pressure plate near the center of the gobo wheel.
8. Push the gobo holder inwards. **DO NOT** force the gobo holder into the gobo wheel slot. If correctly installed, the gobo holder should easily slide into the gobo wheel slot.

Diagram

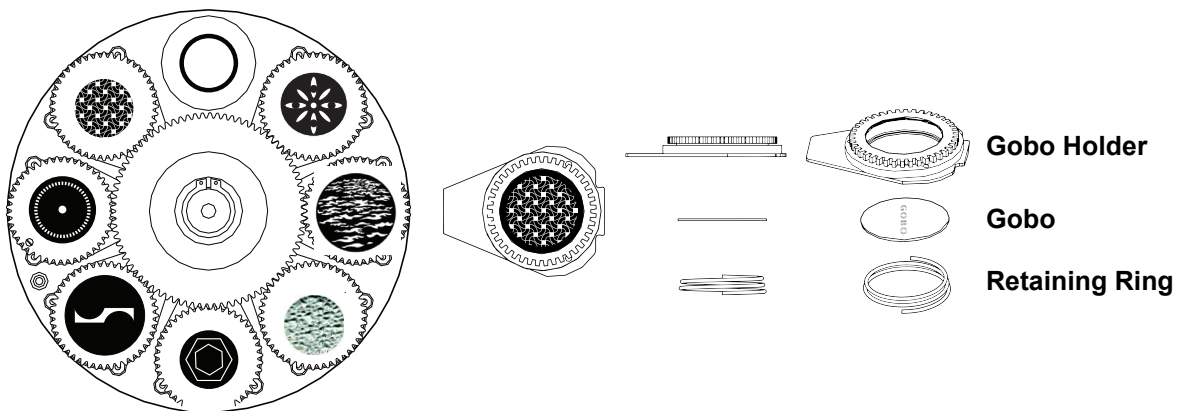
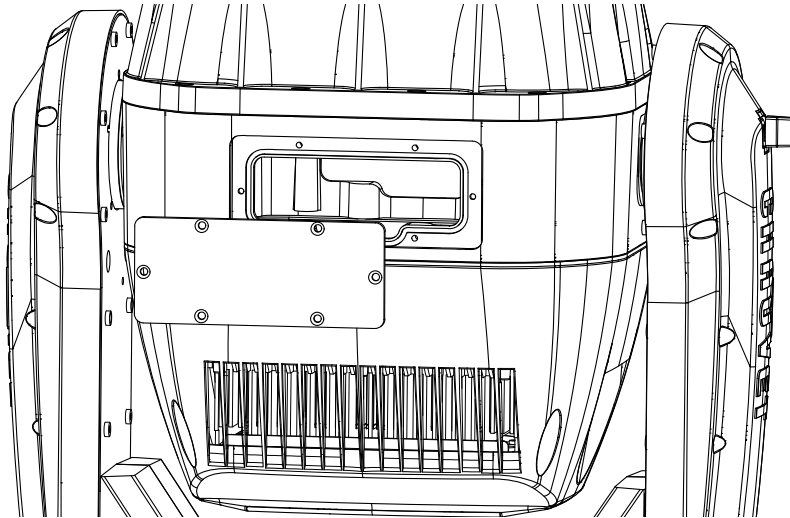

Operation

Color Wheel

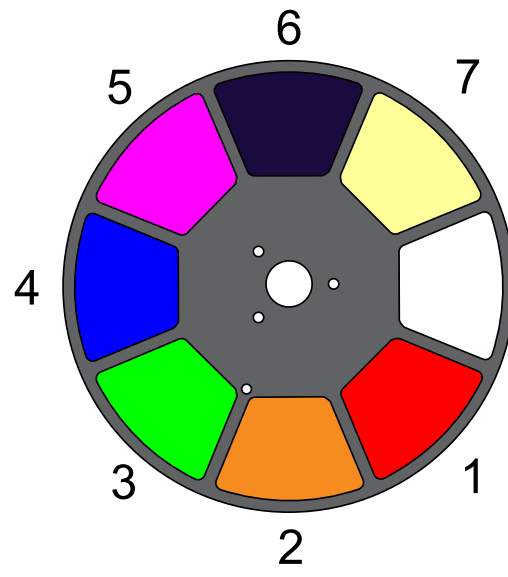

Color Wheel

Color #	Description
1	Red
2	Orange
3	Green
4	Blue
5	Magenta
6	UV
7	CTO

5. Maintenance

Product Maintenance

Dust build-up reduces light output performance and can cause overheating. This can lead to reduction of the light source's life and/or mechanical wear. To maintain optimum performance and minimize wear, clean your lighting products at least twice a month. However, be aware that usage and environmental conditions could be contributing factors to increase the cleaning frequency.

To clean the product, follow the instructions below:

1. Unplug the product from power.
2. Wait until the product is at room temperature.
3. Use a vacuum (or dry compressed air) and a soft brush to remove dust collected on the external surface/vents.
4. Clean all transparent surfaces with a mild soap solution, ammonia-free glass cleaner, or isopropyl alcohol.
5. Apply the solution directly to a soft, lint-free cotton cloth or a lens-cleaning tissue.
6. Softly drag any dirt or grime to the outside of the transparent surface.
7. Gently polish the transparent surfaces until they are free of haze and lint.



Always dry the transparent surfaces carefully after cleaning them.



Do not spin the cooling fans with compressed air. Damage may result.

6. Technical Specifications

Dimensions and Weight

Length	Width	Height	Weight
17.91 in (455 mm)	12.56 in (319 mm)	28.43 in (722 mm)	84.2 lb (38.19 kg)

Note: Dimensions in inches are rounded.

Power

Power Supply Type	Range	Voltage Selection
Switching (internal)	100 to 240 VAC, 50/60 Hz	Auto-ranging

Parameter	100 V, 60 Hz	120 V, 60 Hz	208 V, 60 Hz	230 V, 50 Hz	240 V, 60 Hz
Consumption	730 W	700 W	705 W	704 W	703 W
Operating current	7.10 A	5.82 A	3.32 A	2.97 A	2.86 A
Power-linking current	13.6 A (1 product)	13.6 A (2 products)	3.32 A (4 products)	2.97 A (4 products)	2.86 A (4 products)
Fuse/Breaker	F 20 A, 250 V	F 20 A, 250 V	F 20 A, 250 V	F 20 A, 250 V	F 20 A, 250 V

Power I/O	U.S./Worldwide	UK/Europe
Power input connector	Seetronic Powerkon A	Seetronic Powerkon A
Power cord plug	Edison (U.S.)	Local lug

Light Source

Type	Color	Quantity	Power	Current	Lifespan
LED	Cool white	1	480 W	13.6 A	50,000 hours

Photometrics

Beam Angle	Field Angle	Zoom Range	Cutoff Angle
7° to 42°	8° to 48°	7.1° to 51°	9.2° to 51°
Illuminance @ 5 m (7°)	Illuminance @ 5 m (48°)		
28,829 lux	1,528 lux		

Thermal

Maximum External Temperature	Cooling System
113 °F (45 °C)	Fan-assisted Convection

DMX

I/O Connector	Channel Range
5-pin XLR	26 or 33 channels

Art-Net™/sACN

I/O Connector	Channel Range
Amphenol XLR Net RJ45 in/out	26 or 33 channels

Ordering

Product Name	Item Name	Item Code	UPC Number
Maverick Storm 1 Spot	MAVERICKSTORM1SPOT	08011562	781462219109

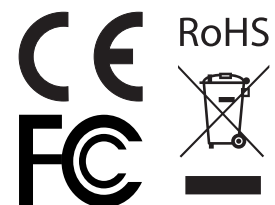

Returns

Send the product prepaid, in the original box, and with the original packing and accessories. Chauvet will not issue call tags.

Call Chauvet and request a Return Merchandise Authorization (RMA) number before shipping the product. Be prepared to provide the model number, serial number, and a brief description of the cause(s) for the return.

To submit a service request online, go to www.chauvetprofessional.com/service-request.

Clearly label the package with an RMA number. Chauvet will refuse any product returned without an RMA number.



Write the RMA number on a properly affixed label. DO NOT write the RMA number directly on the box.

Before sending the product, clearly write the following information on a piece of paper and place it inside the box:

- Your name
- Your address
- Your phone number
- RMA number
- A brief description of the problem

Be sure to pack the product properly. Any shipping damage resulting from inadequate packaging will be your responsibility. FedEx packing or double-boxing are recommended.



Chauvet reserves the right to use its own discretion to repair or replace returned product(s).

Contact Us

General Information	Technical Support
Chauvet World Headquarters	
Address: 5200 NW 108th Ave. Sunrise, FL 33351 Voice: (954) 577-4455 Fax: (954) 929-5560 Toll Free: (800) 762-1084	Voice: (844) 393-7575 Fax: (954) 756-8015 Email: chauvetcs@chauvetlighting.com Website: www.chauvetprofessional.com
Chauvet Europe Ltd	
Address: Unit 1C Brookhill Road Industrial Estate Pinxton, Nottingham, UK NG16 6NT Voice: +44 (0) 1773 511115 Fax: +44 (0) 1773 511110	Email: UKtech@chauvetlighting.eu Website: www.chauvetprofessional.eu
Chauvet Europe BVBA	
Address: Stokstraat 18 9770 Kruishoutem Belgium Voice: +32 9 388 93 97	Email: BNLtech@chauvetlighting.eu Website: www.chauvetprofessional.eu
Chauvet France	
Address: 3, Rue Ampère 91380 Chilly-Mazarin France Voice: +33 1 78 85 33 59	Email: FRtech@chauvetlighting.fr Website: www.chauvetprofessional.eu
Chauvet Germany	
Address: Bruno-Bürgerl-Str. 11 28759 Bremen Germany Voice: +49 421 62 60 20	Email: DEtech@chauvetlighting.de Website: www.chauvetprofessional.eu
Chauvet Mexico	
Address: Av. de las Partidas 34 - 3B (Entrance by Calle 2) Zona Industrial Lerma Lerma, Edo. de México, CP 52000 Voice: +52 (728) 690-2010	Email: servicio@chauvet.com.mx Website: www.chauvetprofessional.mx

Visit the applicable website above to verify our contact information and instructions to request support. Outside the U.S., U.K., Ireland, Benelux, France, Germany, or Mexico, contact the dealer of record.